

REVISION HISTORY				
ZONE	REV	DESCRIPTION	DATE	APPROVED
	1	ENGINEERING RELEASE	2/8/2018	DM
	2	REVISED PIM SPEC	2/8/2018	DM

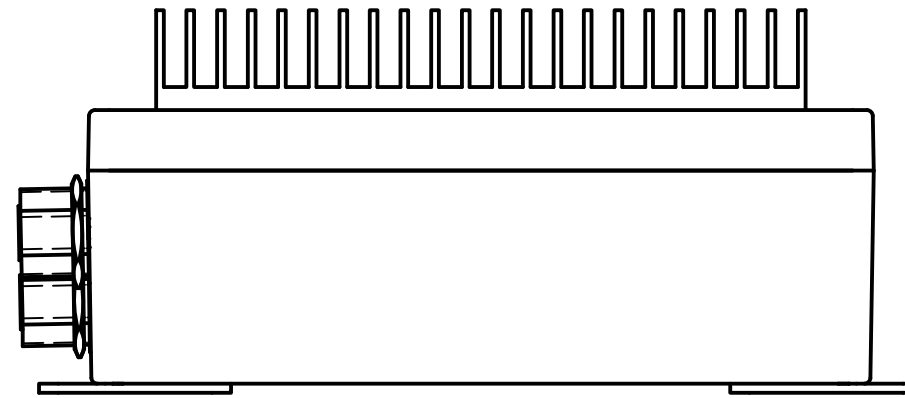
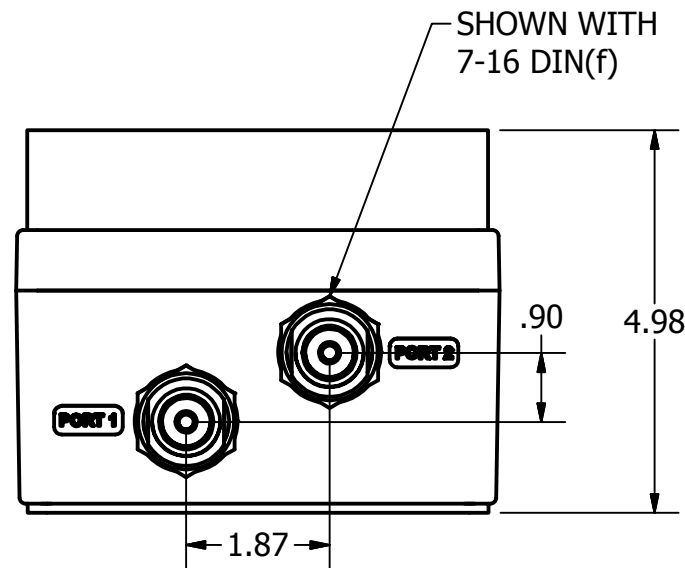

AT-A63-30X VIEW

SPECIFICATION:

FREQUENCY: 380-2700 MHz
 ATTENUATION: 30 dB
 ACCURACY
 380-600: 31.5 dB TYP.
 601-2700: +1.5 / -0.5 dB
 RETURN LOSS
 INPUT: 20dB MIN
 OUTPUT: 18dB MIN
 PIM: 160 dBc
 CONNECTORS: 4.3-10.0, Type N, 7-16 DIN
 POWER: 150W INPUT, 30W REVERSE
 ENVIRONMENT: IP67
 FINISH: BLACK POWDER COAT

*CONNECTORS MAY BE ON THE SAME SIDE OR ON OPPOSITE SIDES.
 SEE PAGE 2 FOR CONNECTORS ON OPPOSITE SIDES

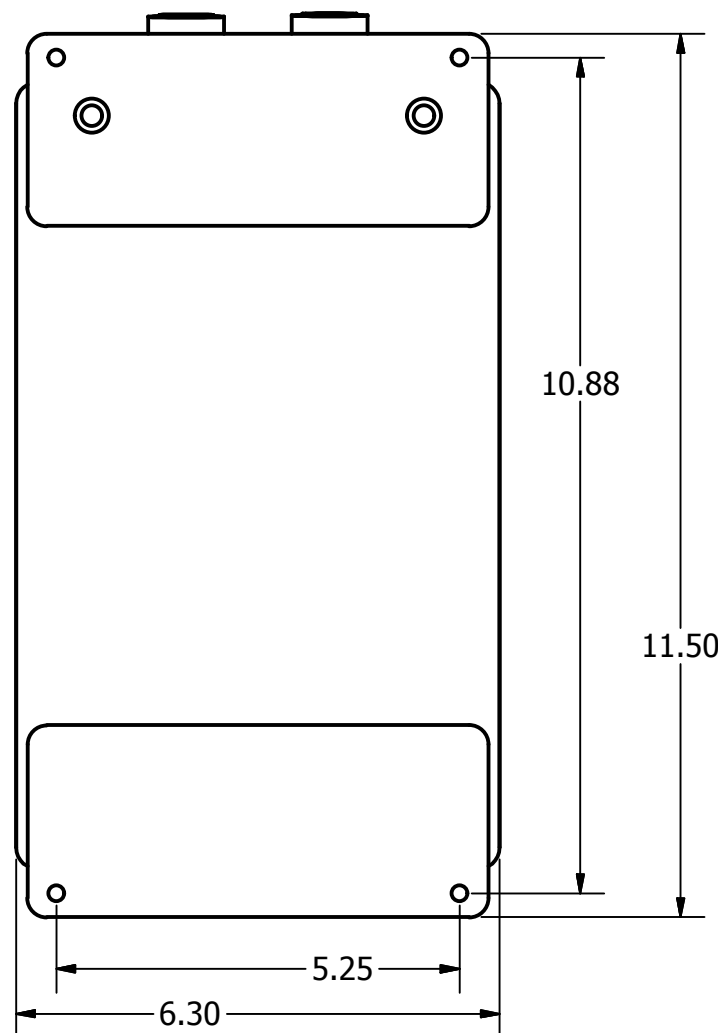

PROPERTY OF R&D MICROWAVES LLC

DRAWN kohamaa	2/22/2017	 R&D Microwaves LLC, USA
CHECKED		
QA		TITLE
MFG		AT-A63 150W ATTENUATION OUTLINE
APPROVED		SIZE B
		DWG NO AT-A63-30X-OLrev2
		SCALE
		REV 2
		SHEET 1 OF 2

4

3

2

1

B

B

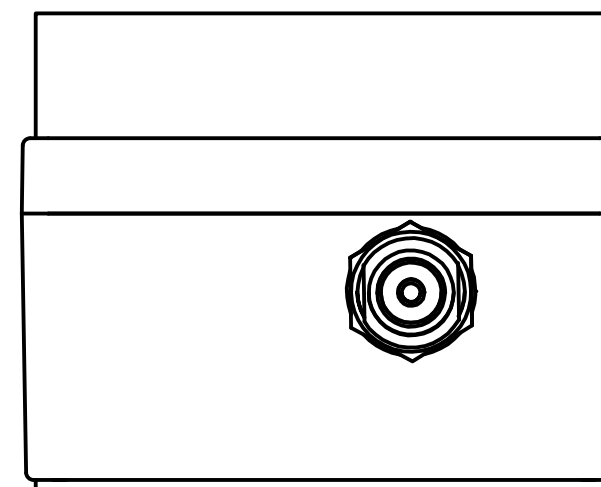
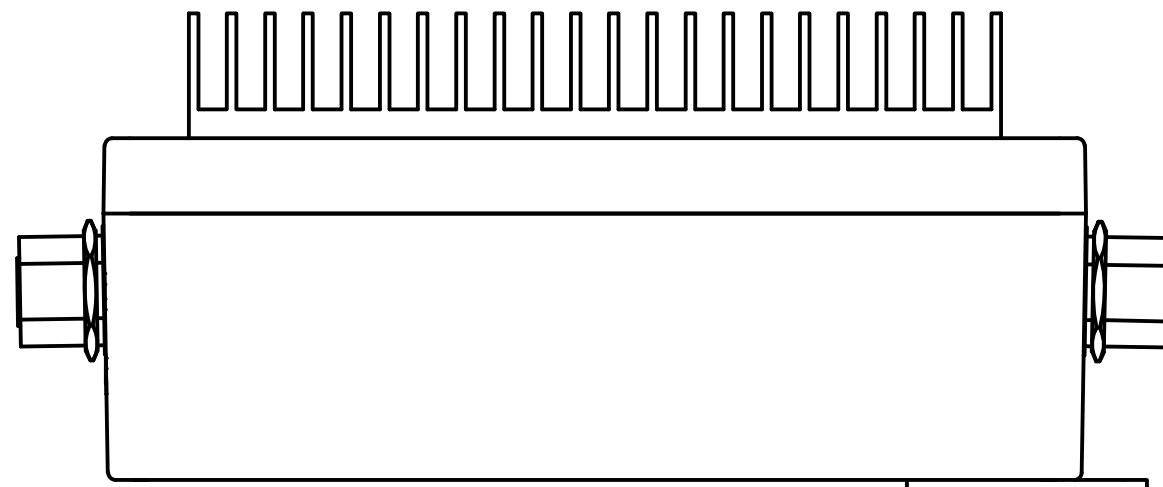
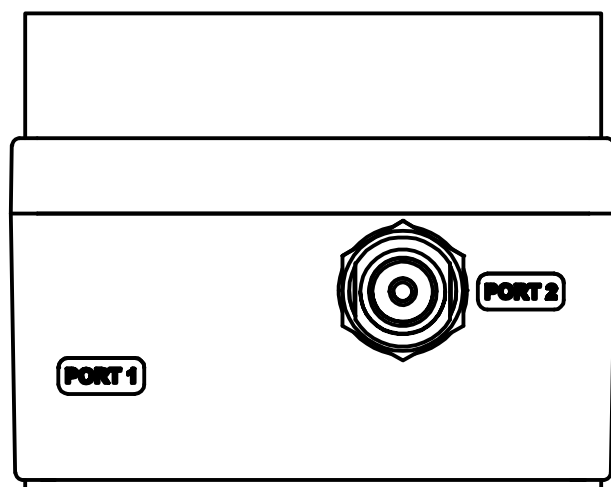

VIEW OF AT-A63A-30X

A

A

DRAWN kohamaa	2/22/2017	 R&D Microwaves LLC, USA
CHECKED		
QA		TITLE
MFG		AT-A63 150W ATTENUATION OUTLINE
APPROVED		SIZE
		B
		DWG NO
		AT-A63-30X-OLrev2
		SCALE
		REV
		2
		SHEET 2 OF 2

4

3

2

1

A

A